

TP-RFC240

Rectangular Food Container with Lid

240 cc

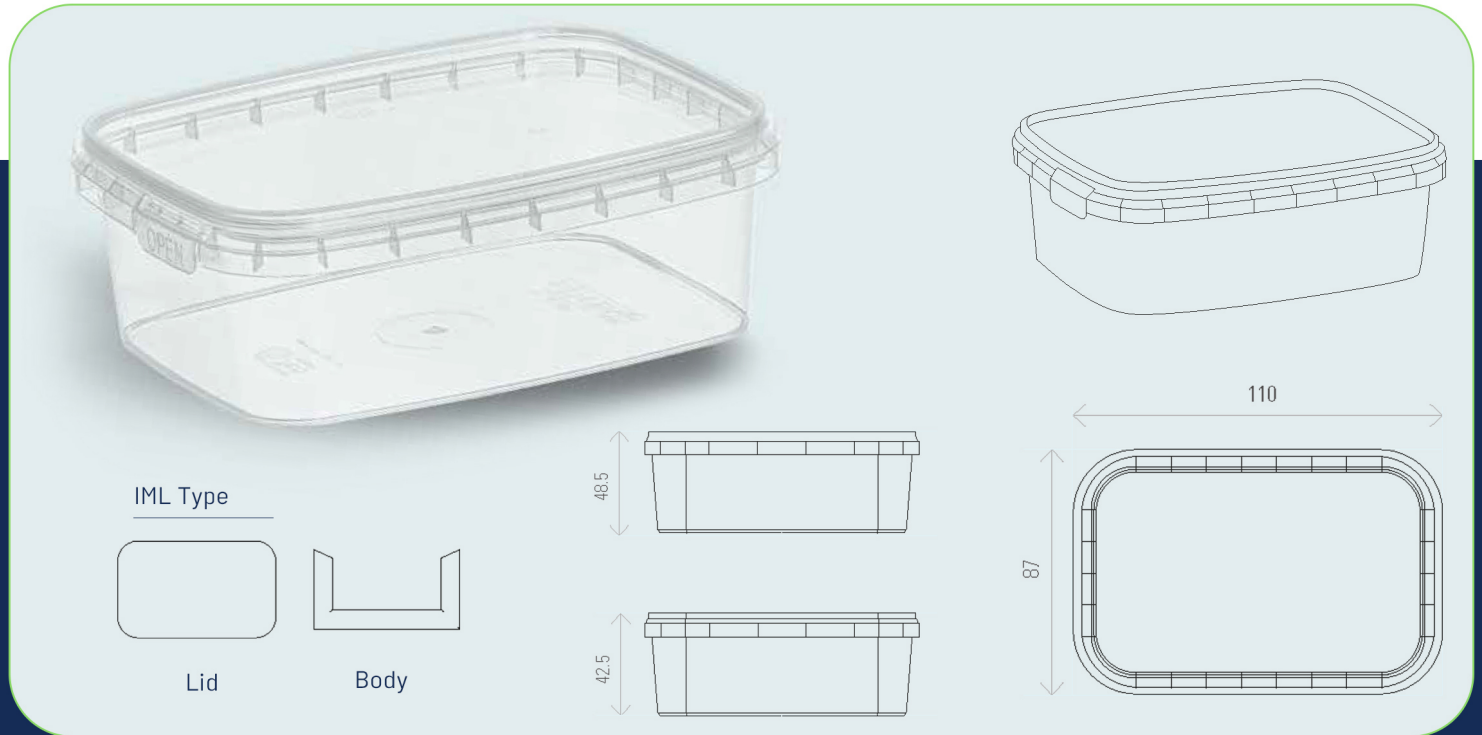

Technical Data	Dimensions (mm)			Volume (cc)	Material
	Length	Width	Height		
TP-RFC240	110	87	48.5	240	PP

Logistic Data	Box Size (mm)			PCS per Box	
	Length	Width	Height	Body	Lid
TP-RFC240	353	265	440	300	300

MOQ (Minimum Order Quantity)
40ft HC Container

Benefits & Options

- * Temperature tolerance: -5°C to +120°C.
- * Microwave-safe
- * Recyclable
- * FDA and HACCP licensed
- * Made from food-grade materials and BPA free
- * IML capability (body, lid)
- * Also suitable for oils, fats, and household chemicals
- * Hardware and Tamper evident (set)
- * Dishwasher-safe
- * Thin wall and Lacquers
- * Deep Freeze Additive
- * Optional color
- * Minimum order can include multiple sizes (negotiable for trials)